

FEATURES

- Specific design for pulse signals
- Accommodate a variety of pulse formats
- High pulse fidelity

APPLICATIONS

- Pulse generation
- Pulse picking
- Spectroscopy
- Lidar

OPTIONS

- Heat-sink

The DR-PL-20-MO RF drivers are amplifiers module designed to drive LiNbO₃ optical modulators so as to generate undistorted optical pulses.

Electrical pulsed signals differ from classical telecom signals by long periods with no signal, when telecom signals are usually well balanced in 1 and 0. They also differ from analog signal by a wider frequency content. In order to generate clean optical pulses with sharp edges, sustained high and low levels and no overshoot, pulsed signals do require specific amplifiers.

The DR-PL-20-MO driver is optimized for low and high Pulse Repetition Frequency (PRF) signals from 10 Hz to 1 GHz. The bandwidth up to 20 GHz accommodates 50 ps narrow pulse width with short rise and fall time (down to 30 ps) and can withstand longer pulses up to 10 ns.

The DR-PL-20-MO drivers come in compact connectorized modules that match directly with Photline modulators, they use a single voltage power supply for ease and safety of use and feature an output voltage control for maximum flexibility. An optional heat sink is proposed as an accessory.

Performance Highlights

| Parameter | Min | Typ | Max | Unit |
|----------------------------|------|-----|------|-----------------|
| Cut-off frequencies | 45 k | - | 18 G | Hz |
| Output pulse amplitude | - | - | 5.2 | V _{pp} |
| Gain | 28 | 30 | - | dB |
| Pulse repetition frequency | 10 | - | 1 G | Hz |
| Pulse width | 60 p | - | 10 n | s |
| Rise / Fall time | - | 20 | 35 | ps |

DC Electrical Characteristics

| Parameter | Symbol | Min | Typ | Max | Unit |
|----------------------------------|------------|-----|-----|-----|------|
| Supply voltage (fixed) | V_{bias} | - | 12 | - | V |
| Supply current | I_{bias} | - | 320 | 400 | mA |
| Output amplitude control voltage | V_{amp} | 0 | - | 1.2 | V |
| Output pulse adjustment voltage | V_{xp} | 0 | 0.8 | 1.1 | V |

Electrical Characteristics

| Parameter | Symbol | Condition | Min | Typ | Max | Unit |
|----------------------------|------------------|---|------|-----------|------|-----------------|
| Lower frequency | $f_{3dB, lower}$ | -3 dB point | 45 | 50 | - | kHz |
| Upper frequency | $f_{3dB, upper}$ | -3 dB point | 18 | 20 | - | GHz |
| Gain | S_{21} | Small signal, $P_{in} = -30$ dBm | 28 | 30 | - | dB |
| Gain ripple | - | < 17 GHz | - | ± 1.5 | - | dB |
| Input return loss | S_{11} | 50 kHz < f < 12 GHz | - | - | -10 | dB |
| Output return loss | S_{22} | 50 kHz < f < 20 GHz | - | - | -10 | dB |
| Output pulse amplitude | V_{out} | $V_{in} = 250$ mV _{pp} , by V_{amp} adjustment | 1.5 | 4.5 | 5.2 | V _{pp} |
| Sat output pulse amplitude | V_{out} | $V_{in} = 500$ mV _{pp} | - | - | 5.4 | V _{pp} |
| Pulse repetition frequency | PRF | Duty-cycle < 0.1 % | 10 | - | 1 G | Hz |
| Pulse width | PW | 10 Hz < PRF < 1 GHz | 60 p | - | 10 n | s |
| Rise / Fall time | t_R / t_F | 20 % - 80 % | - | 20 | 35 | ps |
| Power dissipation | P | - | - | 3.8 | 5.2 | W |

Conditions: S parameters -30 dBm, $T_{amb} = 25^\circ\text{C}$, 50 Ω system

Absolute Maximum Ratings

Stresses in excess of the absolute maximum ratings can cause permanent damage to the device. These are absolute stress ratings only. Functional operation of the device is not implied at these or any other conditions in excess of those given in the operational sections of the data sheet. Exposure to absolute maximum ratings for extended periods can adversely affect device reliability.

| Parameter | Symbol | Min | Max | Unit |
|--------------------------|------------|-----|-------|------------------|
| RF input voltage | V_{in} | - | 0.5 | V _{pp} |
| Supply Voltage | V_{bias} | - | 13 | V |
| DC current | I_{bias} | - | 0.400 | A |
| Pulse amplitude control | V_{amp} | 0 | 1.2 | V |
| Pulse adjustment control | V_{xp} | 0 | 1.1 | V |
| Power dissipation | P_{diss} | - | 5.2 | W |
| Temperature of operation | T_{op} | -5 | +40 | $^\circ\text{C}$ |
| Storage temperature | T_{st} | -20 | +70 | $^\circ\text{C}$ |

S_{21} and Group Delay Parameter Curves

Conditions: $V_{bias} = 12\text{ V}$, $V_{amp} = 1.2\text{ V}$, $V_{xp} = 0.8\text{ V}$, $I_{bias} = 300\text{ mA}$

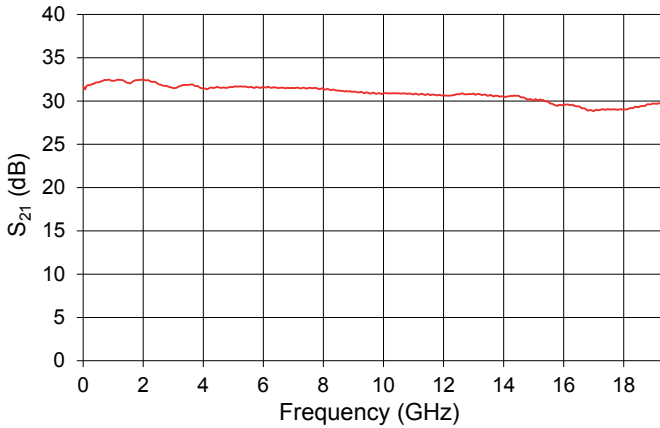

Group Delay Parameter Curve

Conditions: $V_{bias} = 12\text{ V}$, $V_{amp} = 1.2\text{ V}$, $V_{xp} = 0.8\text{ V}$, $I_{bias} = 300\text{ mA}$

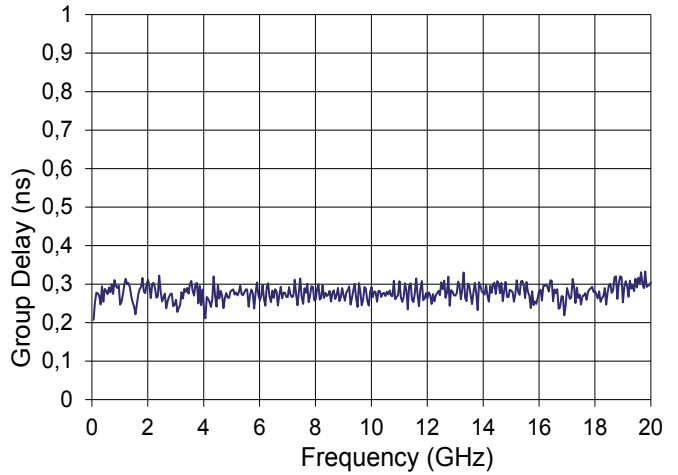

S_{22} Parameter Curve

Conditions: $V_{bias} = 12\text{ V}$, $V_{amp} = 1.2\text{ V}$, $V_{xp} = 0.8\text{ V}$, $I_{bias} = 300\text{ mA}$

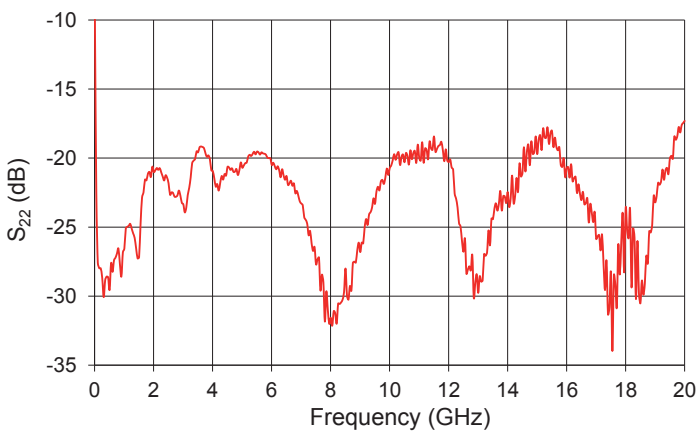

S_{11} Parameter Curve

Conditions: $V_{bias} = 12\text{ V}$, $V_{amp} = 1.2\text{ V}$, $V_{xp} = 0.8\text{ V}$, $I_{bias} = 300\text{ mA}$

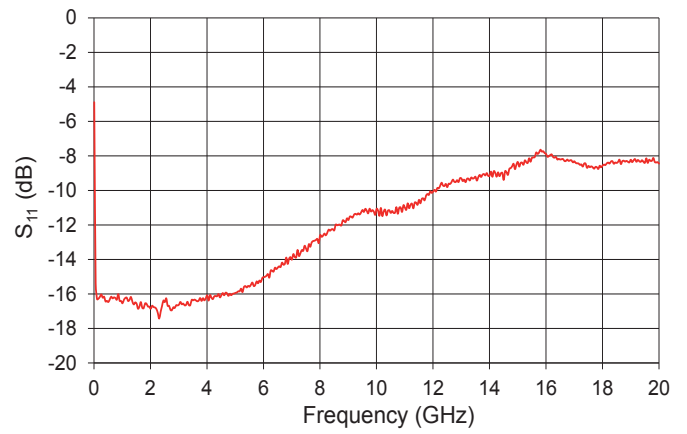

S_{12} Parameter Curve

Conditions: $V_{bias} = 12\text{ V}$, $V_{amp} = 1.2\text{ V}$, $V_{xp} = 0.8\text{ V}$, $I_{bias} = 300\text{ mA}$

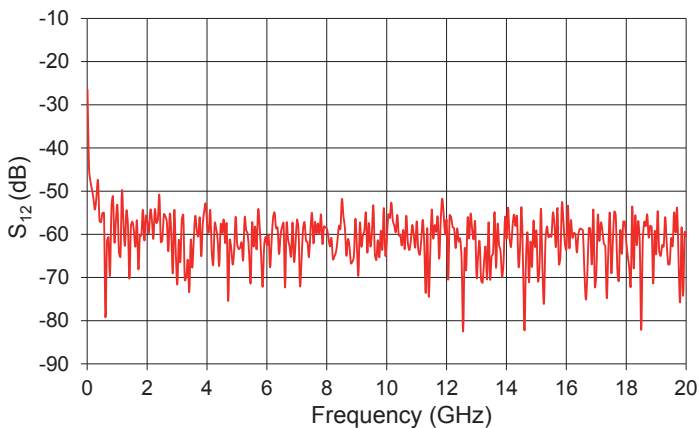

Typical Output Voltage Amplitude vs V_{amp}

Conditions: $V_{bias} = 12\text{ V}$, $V_{xp} = 0.8\text{ V}$, $V_{in} = 0.3\text{ V}_{pp}$

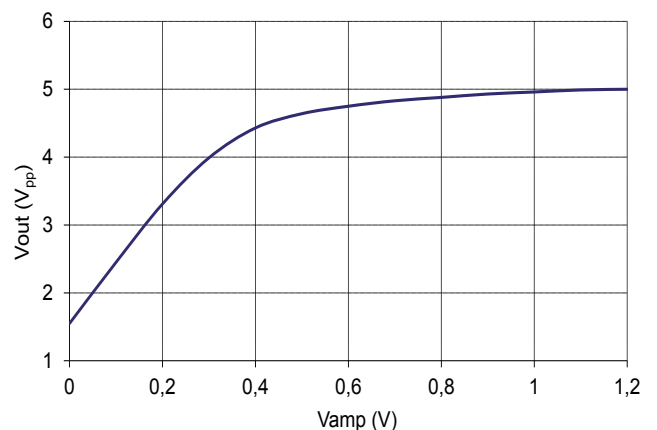

Pulses Measurements

Conditions: Input signal

The input electrical signal is generated by Anritsu MP1800A. Measured using Agilent 86100B with two 50 GHz 8348A channels module.

Low frequency repetition rate with a short pulse width of PW = 60 ps

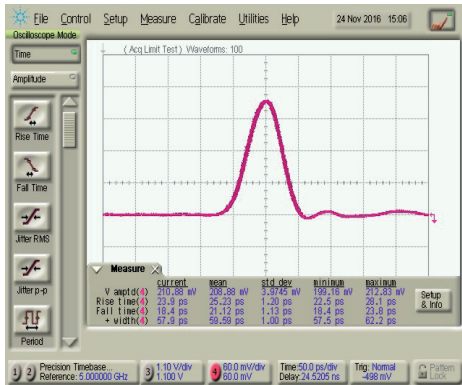

Input signal: Pulse amplitude = 0.227 V_{pp}, Rise time = 24 ps

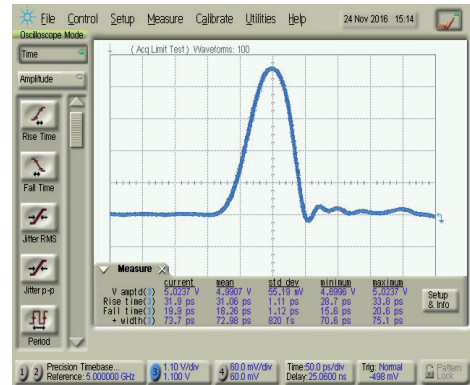

Output response: Pulse amplitude = 5 V_{pp}, Rise time = 32 ps

Low frequency repetition rate with a short pulse width of PW = 1 ns

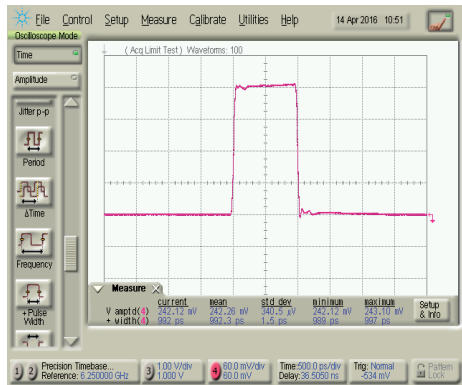

Input signal: Pulse amplitude = 0.242 mV_{pp}, Rise time = 32 ps

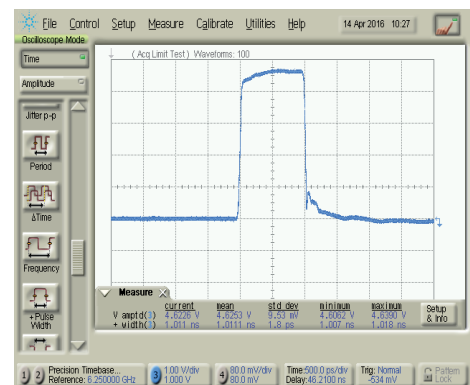

Output response: Pulse amplitude = 4.6 V_{pp}, Rise time = 32 ps

Low frequency repetition rate with a pulse width of PW = 10 ns

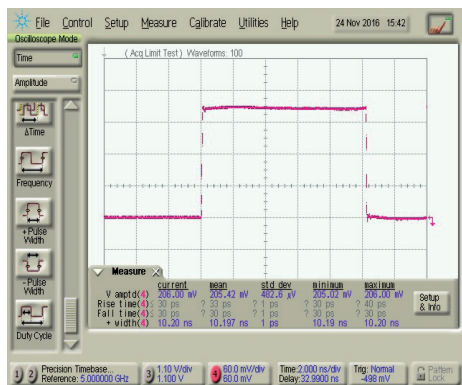

Input signal: Pulse amplitude = 0.24 mV_{pp}, Rise time = 32 ps

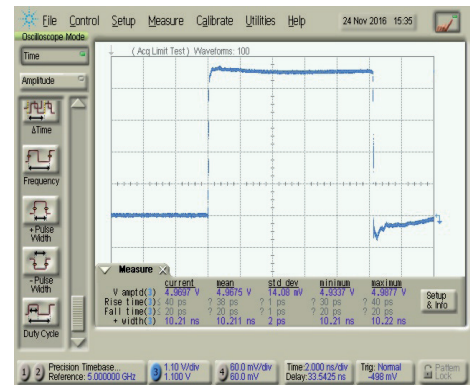

Output response: Pulse amplitude = 4.96 V_{pp}, Rise time = 32 ps

Electrical Schematic Diagram

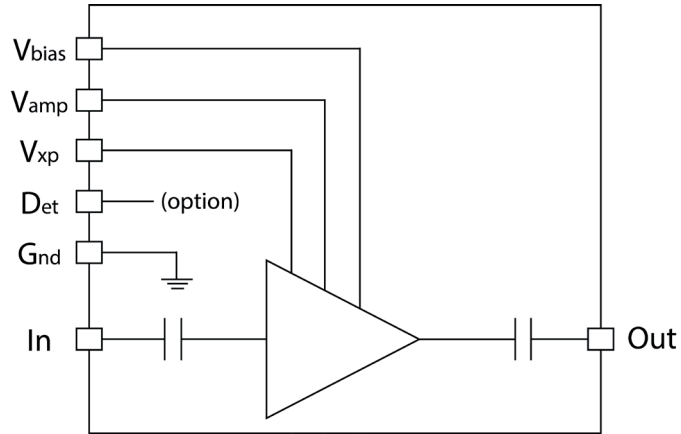

Mechanical Diagram and Pinout

All measurements in mm

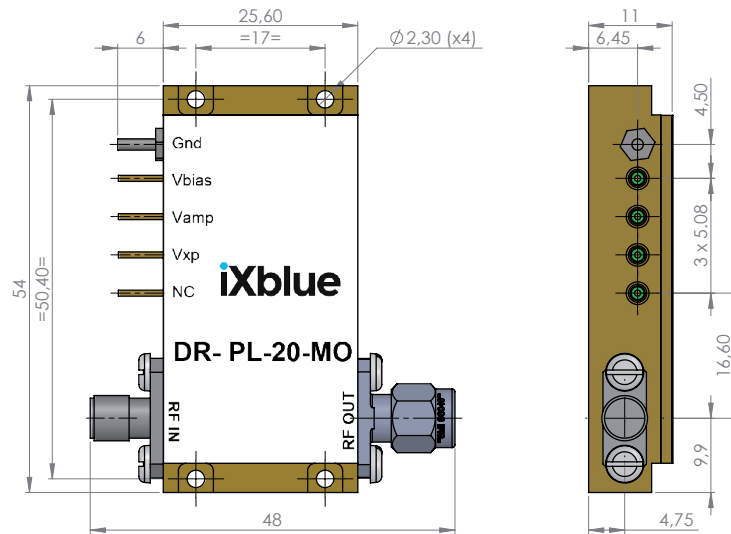

The heatsinking of the module is necessary. It's user responsibility to use an adequate heatsink. Refer to page 6 for ixBlue recommended heatsink.

| PIN | Function | Unit |
|-------------------|-------------------------------------|--|
| IN | RF In | K connector female |
| OUT | RF Out | K connector male |
| V _{bias} | Power supply voltage | Set a typical operating specification |
| V _{amp} | Output voltage amplitude adjustment | Adjust for gain control tuning |
| V _{xp} | Output pulse adjustment | Adjust for pulse adjustment (amplitude and width) tuning |
| Det | RF power detector | Not available |

Mechanical Diagram And Pinout With HS-MO2 Heatsink

All measurements in mm

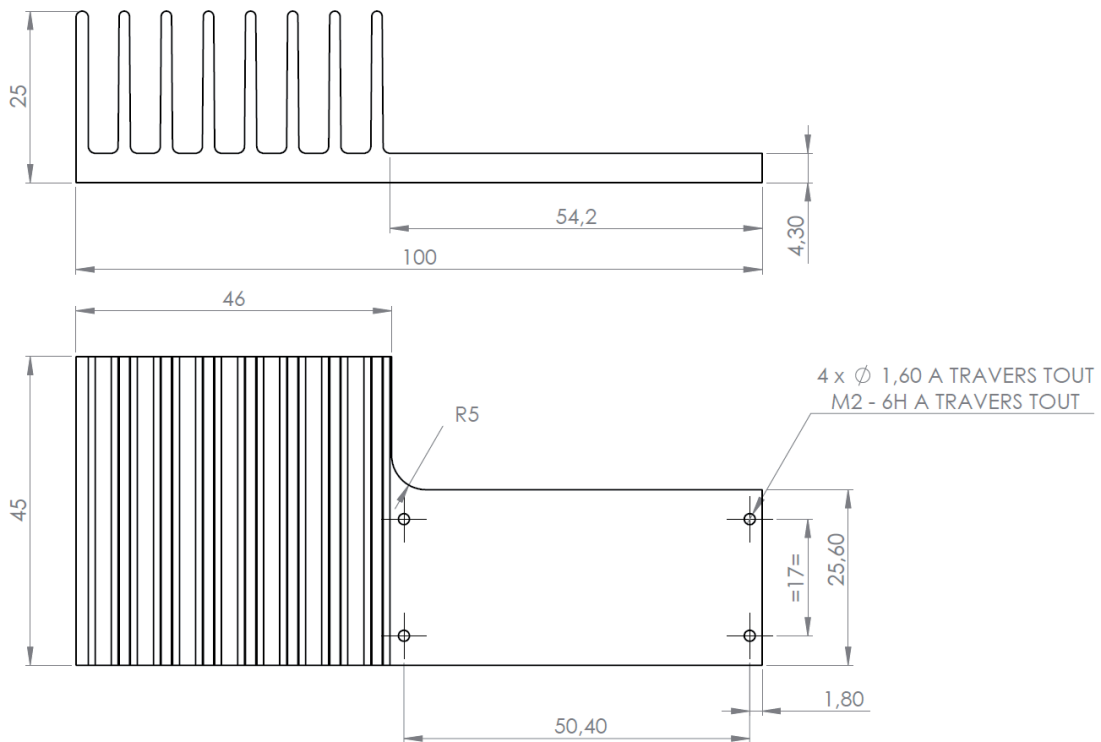
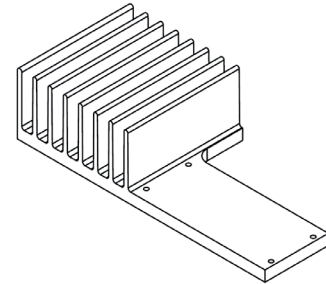

About us

ixBlue Photonics produces specialty optical fibers and Bragg gratings based fiber optics components and provides optical modulation solutions based on the company lithium niobate (LiNbO₃) modulators and RF electronic modules.

ixBlue Photonics serves a wide range of industries: sensing and instruments, defense, telecommunications, space and fiber lasers as well as research laboratories all over the world.

3, rue Sophie Germain
25 000 Besançon - FRANCE
Tel. : +33 (0) 381 853 180 - Fax : + 33 (0) 381 811 557

ixblue reserves the right to change, at any time and without notice, the specifications, design, function or form of its products described herein. All statements, specification, technical information related to the products herein are given in good faith and based upon information believed to be reliable and accurate at the moment of printing. However the accuracy and completeness thereof is not guaranteed. No liability is assumed for any inaccuracies and as a result of use of the products. The user must validate all parameters for each application before use and he assumes all risks in connection with the use of the products